

■ Snow ploughs



Go
Your
Way!



www.zaugg.swiss

One of ZAUGG's core competences is the development, design and manufacture of high quality, technically advanced snow ploughs for snow clearance on all traffic areas, roads and footpaths as well as at aerodromes.

The ploughs can easily be mounted on two-wheel tractors, municipal service vehicles and all-wheel-drive vehicles, tractors, vans, Unimogs, trucks, wheel/skid-steer loaders, fork-lift trucks and airport clearance vehicles from a very wide range of vendors.

The different models are designed for the most diverse applications and are adapted to suit the individual customer's needs according to usage conditions and requirements.



Snow ploughs



Snow plough G3
Page 6



Snow plough G40K
Page 16



Snow plough G6
Page 8



Snow plough G50K
Page 17



Snow plough G8K
Page 9



Snow plough VARIO4
Page 18



Snow plough G16
Page 10



Snow plough SP3000
Page 19



Snow plough G21
Page 11



Side-blade snow plough
SFRG22K
Page 20



Snow plough G32
Page 12



Side-blade snow plough
SG50K
Page 21



Snow plough G33
Page 14



Side plough SSR
Page 22



Snow plough G44
Page 15

Trip edge system
Page 4

Wear rail
Page 5

Mounting device
Page 23

Options
Page 24-25

Controllers
Page 26

After-sales
Page 27

■ Trip edge system

The ZAUGG trip edge system with single-arm suspension enables optimal adaptation to the road profile.

Clearance speeds of up to 60 km/h are possible without restricting safety. Due to the single-arm suspension, the snow is also reliably cleared in ruts and on cambered and uneven roads. Due to the trip edge system only a small mass is accelerated, which increases driving comfort and protects the material and the carrier vehicle.

Two different trip edge systems are installed in the different snow ploughs.

The cable-pull trip edge system:

The cable-pull variant enables the snow plough to be used even without a support (support wheel, skid). However, the use of device relief is recommended. In the event of a collision with an obstacle, the element can move freely and independently in height and angle.

The lever-controlled trip edge system:

A consistent further development of the cable-pull system enables the moving parts on the system to be reduced to a minimum, so that fewer wearing parts are required. The cable-pull is replaced by a control lever, resulting in forced control of the element when cushioning. Support in the form of support wheels or skids is required.



Optimal adaptation to the road profile



■ Wear rail

So that the snow plough is optimally configured for the different usage requirements, various wear rails are available.



Steel wear rails

- aggressive stripping effect
- inexpensive
- robust

Main areas of application:

- solidly compacted snow covering
- complete clearance
- higher altitudes



Combination wear rail

- long service lives and quietness
- very good sliding characteristics
- limited aggressiveness

Main areas of application:

- Municipalities
- Towns
- Country and cantonal roads
- Motorways



PUR wear rail

- protects surfaces
- optimal ground adaptation
- low noise
- elastic, flexible
- shock-absorbing
- available in various degrees of hardness

Main areas of application:

- Municipalities
- Towns



Rubber-corrundum wear rail

- elastic
- low noise
- protects surfaces
- insensitive to obstacles

Main areas of application:

- Motorways
- Cantonal roads

■ Snow plough G3

The little one from ZAUGG is suitable for mounting on small tractors, small municipal service vehicles, fork-lift trucks and two-wheel tractors. The plough body is secured against collisions with obstacles by means of hollow rubber springs.

It is used for snow clearance on paths, factory sites and narrow roads.



■ TECHNICAL DATA

	125	140	150	160	180
Plough length (cm)	125	140	150	160	180
Clearing width B at a blade angle of 35° (cm)	105	119	125	131	150
Plough height at the outside (cm)	48	60	60	60	60
Plough height in the middle (cm)	48	52	52	52	52
Total weight with attachment unit (approx. kg)	100	115	120	125	135



Photos show snow plough with special equipment



Snow plough G6

Trip edge system:
Lever-controlled

The G6 is the smallest snow plough equipped with the patented ZAUGG trip edge system.

Its weight-optimised design is thus suitable for mounting on light carrier vehicles such as 4x4 vehicles, compact tractors (up to approx. 40 kW), municipal service vehicles, skid-steer loaders and fork-lift trucks.



TECHNICAL DATA

	160	180	200	220	240
Spring elements (no.)	1	1	1	1	1
Plough length (cm)	160	180	200	220	240
Plough height with steel wear rail (cm)	70	70	70	70	70
Clearing width B at a blade angle of 32° (cm)	136	153	170	187	204
Clearing width B at a blade angle of 45° (cm)	113	127	141	156	170
b1 32° (cm)	86	94	103	111	120
b2 32° (cm)	50	58	67	75	84
b1 45° (cm)	81	88	95	102	109
b2 45° (cm)	33	40	47	54	61
Passage width C at a blade angle of 32° (cm)	151	168	185	202	219
Passage width C at a blade angle of 45° (cm)	133	147	161	175	189
Total weight with attachment unit (approx. kg)	200	210	220	230	240
Total weight with VSS-B (approx. kg)	—	280	290	300	310

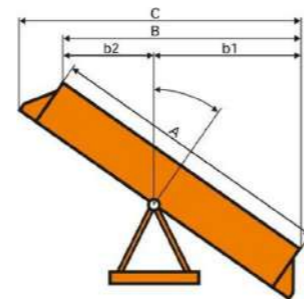

Photos show snow plough with special equipment

Snow plough G8K

Trip edge system:
Cable-pull system

The G8K is a two-part plough that makes driving over obstacles more comfortable and thus further reduces the load on the carrier vehicle.

It is suitable for mounting on 4x4 vehicles, compact tractors (up to approx. 60 kW), municipal service vehicle and skid-steer loaders.

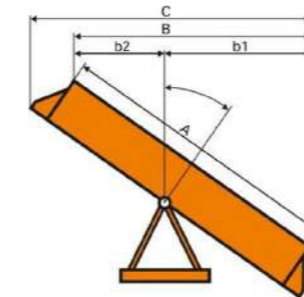

TECHNICAL DATA

	160	180	200	220	240
Spring elements (no.)	2	2	2	2	2
Plough length (cm)	160	180	200	220	240
Plough height with steel wear rail (cm)	80	80	80	80	80
Clearing width B at a blade angle of 32° (cm)	136	153	170	187	204
Clearing width B at a blade angle of 45° (cm)	113	127	141	156	170
b1 32° (cm)	87	96	104	113	121
b2 32° (cm)	48	57	65	74	82
b1 45° (cm)	83	90	97	104	111
b2 45° (cm)	31	38	45	52	59
Passage width C at a blade angle of 32° (cm)	151	168	185	202	219
Passage width C at a blade angle of 45° (cm)	136	150	164	179	193
Total weight with attachment unit (approx. kg)	250	260	270	280	290
Total weight with VSS-B (approx. kg)	290	300	310	320	330



Photos show snow plough with special equipment

Snow plough G16

Trip edge system:
Lever-controlled

With its weight-optimised design, the G16 is particularly suitable for vans with a low available payload on the front axle.

Carrier vehicles are primarily vans and municipal service vehicles up to approx. 80 kW and wheel loaders up to 4.5 t.



TECHNICAL DATA

	220	240	260	280	300
Spring elements (no.)	2	2	2	2	2
Plough length (cm)	220	240	260	280	300
Plough height with steel wear rail (cm)	86	86	86	86	86
Clearing width B at a blade angle of 35° (cm)	180	197	213	229	246
Clearing width B at a blade angle of 45° (cm)	156	170	184	198	212
b1 35° (cm)	115	123	131	140	148
b2 35° (cm)	65	73	81	90	98
b1 45° (cm)	109	116	123	130	137
b2 45° (cm)	47	54	61	68	75
Passage width C at a blade angle of 35° (cm)	200	217	233	249	266
Passage width C at a blade angle of 45° (cm)	181	195	209	223	237
Weight with steel wear rail, three-point-attachment unit cat. 2 (approx. kg)	360	370	380	390	400
Weight with steel wear rail, parallelogram with attachment plate VSS-B (approx. kg)	380	390	400	410	420

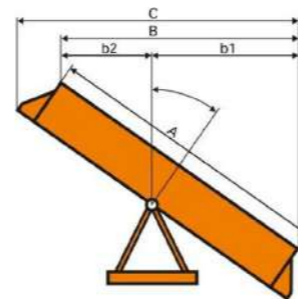

Photos show snow plough with special equipment

Snow plough G21

Trip edge system:
Lever-controlled

The G21 is the largest model from the ZAUGG small snow plough range.

Thanks to its robust design it is suitable for vans, municipal service vehicles, Unimogs and tractors (up to approx. 90 kW) as well as wheel loaders up to 5.5 t.

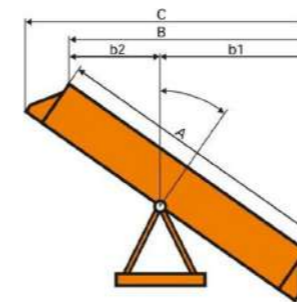

TECHNICAL DATA

	240	260	280	300
Spring elements (no.)	2	2	2	2
Plough length (cm)	240	260	280	300
Plough height with steel wear rail (cm)	92	92	92	92
Clearing width B at a blade angle of 35° (cm)	197	213	229	246
Clearing width B at a blade angle of 45° (cm)	170	184	198	212
b1 35° (cm)	123	131	139	147
b2 35° (cm)	74	82	90	98
b1 45° (cm)	115	122	129	136
b2 45° (cm)	55	62	69	76
Passage width C at a blade angle of 35° (cm)	217	233	249	266
Passage width C at a blade angle of 45° (cm)	194	208	222	237
Weight with steel wear rail, three-point-attachment unit cat. 2 (approx. kg)	460	475	490	505
Weight with steel wear rail, parallelogram with attachment plate VSS-B (approx. kg)	510	525	540	555



Photos show snow plough with special equipment

Snow plough G32

Trip edge system:
Lever-controlled

Thanks to its 125 cm-high, open blade form, the G32 is universally usable.

Suitable carrier vehicles are trucks, Unimogs, large tractors up to approx. 140 kW and wheel loaders up to 12 t.

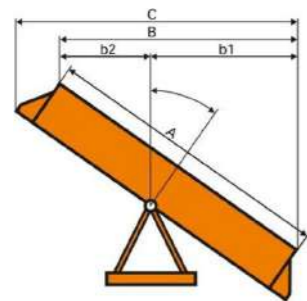

TECHNICAL DATA

	280	300	330	360	390	360	400	440
Spring elements (no.)	2	2	3	3	3	4	4	4
Plough length (cm)	280	300	330	360	390	360	400	440
Plough height with steel wear rail (cm)	125	125	125	125	125	125	125	125
Clearing width B at a blade angle of 35° (cm)	229	246	270	295	319	295	328	360
Clearing width B at a blade angle of 45° (cm)	198	212	233	255	276	255	283	311
b1 35° (cm)	146	154	166	178	191	178	195	211
b2 35° (cm)	84	92	104	116	129	116	133	149
b1 45° (cm)	137	144	155	165	176	165	179	194
b2 45° (cm)	61	68	79	89	100	89	103	118
Passage width C at a blade angle of 35° (cm)	261	277	302	326	351	326	359	392
Passage width C at a blade angle of 45° (cm)	231	246	267	288	309	288	316	345
Weight with combination wear rail S=36, three-point attachment unit cat. 2 (approx. kg)	820	840	930	960	990	1020	1060	1100
Weight with combination wear rail S=36, parallelogram with attachment plate VSS-A, support wheels and snow dust deflector (approx. kg)	930	950	1110	1140	1170	1200	1240	1280



Photos show snow plough with special equipment



Snow plough G33

Trip edge system:
Cable-pull system

The universally used snow plough G33 is suitable for flatlands as well as mountain areas. It can be equipped with up to 3 spring elements and can be used without support wheels.

Suitable carrier vehicles are trucks, Unimogs, wheel loaders and tractors.



Snow plough G44

Trip edge system:
Cable-pull system

The G44 is a high-alpine snow plough. With a plough height of 140 cm, the ejection of large quantities of snow over high snow embankments is ensured.

Suitable carrier vehicles are powerful trucks and wheel loaders from 8.5 t.

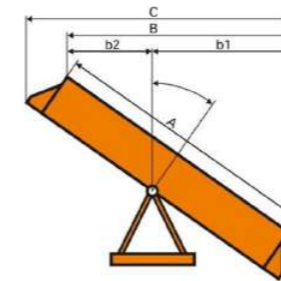
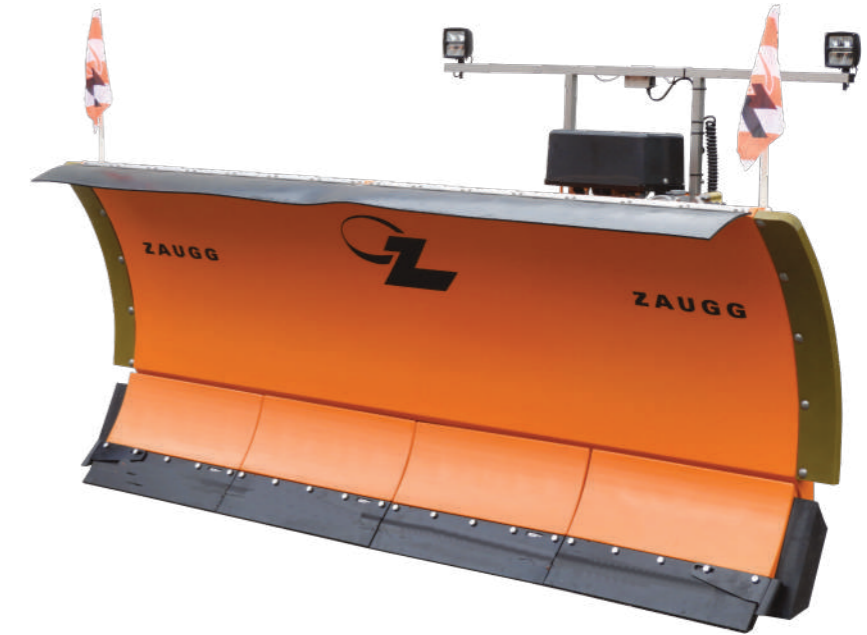

TECHNICAL DATA

	260	280	300	330	360	390
Spring elements (no.)	3	3	3	3	3	3
Plough length (cm)	260	280	300	330	360	390
Plough height with steel wear rail (cm)	120	120	120	120	120	120
Clearing width B at a blade angle of 35° (cm)	213	229	246	270	295	319
Clearing width B at a blade angle of 45° (cm)	184	198	212	233	255	276
b1 35° (cm)	133	142	150	162	174	187
b2 35° (cm)	79	88	96	108	120	133
b1 45° (cm)	125	132	139	150	160	171
b2 45° (cm)	59	66	73	84	94	105
Passage width C at a blade angle of 35° (cm)	245	261	278	302	327	351
Passage width C at a blade angle of 45° (cm)	218	232	246	267	289	310
Weight with combination wear rail S=36, parallelogram with attachment plate VSS-A and snow dust deflector (approx. kg)	840	860	930	970	1010	1060
Weight with combination wear rail S=36, three-point attachment unit cat. 2 (approx. kg)	710	730	800	830	860	890

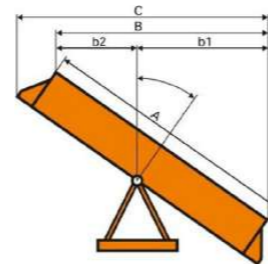

Photos show snow plough with special equipment

TECHNICAL DATA

	340	360	400	450
Spring elements (no.)	4	4	4	4
Plough length (cm)	340	360	400	450
Plough height with steel war rail (cm)	140	140	140	140
Clearing width B at a blade angle of 35° (cm)	279	295	328	269
Clearing width B at a blade angle of 45° (cm)	240	255	283	318
b1 35° (cm)	168	178	193	213
b2 35° (cm)	110	118	135	155
b1 45° (cm)	155	162	176	194
b2 45° (cm)	85	92	106	124
Passage width C at a blade angle of 35° (cm)	322	338	371	412
Passage width C at a blade angle of 45° (cm)	293	308	336	371
Weight with combination wear rail S=36, parallelogram with attachment plate VSS-A, support wheels and snow dust deflector (approx. kg)	1200	1240	1280	1380



Photos show snow plough with special equipment

Snow plough G40K

Trip edge system:
Cable-pull system

The G40K is a semi-closed snow plough and was specially developed for use in densely populated regions. Its low height of just 950 mm improves visibility in use.

The combined design of steel and plastic makes it a lightweight unit. Suitable carrier vehicles are trucks and Unimogs.



TECHNICAL DATA

	300	330	320	340	360	400
Spring elements (no.)	3	3	4	4	4	4
Plough length (cm)	300	330	320	340	360	400
Plough height with steel wear rail (cm)	95	95	95	95	95	95
Clearing width B at a blade angle of 35° (cm)	246	270	262	279	295	328
Clearing width B at a blade angle of 45° (cm)	212	233	226	240	255	283
b1 35° (cm)	150	163	159	167	175	191
b2 35° (cm)	95	108	104	112	120	136
b1 45° (cm)	140	151	147	154	161	175
b2 45° (cm)	72	82	79	86	93	107
Passage width C at a blade angle of 35° (cm)	272	297	289	305	321	354
Passage width C at a blade angle of 45° (cm)	241	262	255	269	284	312
Passage width C at a blade angle of 55° (cm) with LSE	223	242	263	249	262	288
Weight with combination wear rail S=36, parallelogram with attachment plate VSS-A, support wheels and snow dust deflector (approx. kg)	870	900	920	940	960	1000

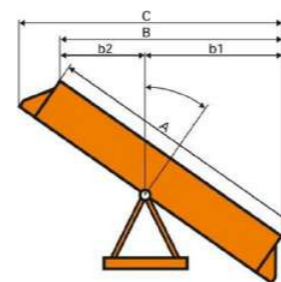

Photos show snow plough with special equipment



Snow plough G50K

Trip edge system:
Cable-pull system

The G50K is regarded as the motorway snow plough par excellence. It was designed for use at high clearance speeds. This was achieved with a closed blade form that enables the best possible snow flow.

Suitable carrier vehicles are trucks and Unimogs.

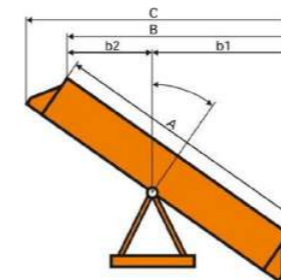

TECHNICAL DATA

	330	320	360	400	440	450	500	550	600
Spring elements (no.)	3	4	4	4	4	5	5	5	6
Plough length (cm)	330	320	360	400	440	450	500	550	600
Plough height with steel wear rail (cm)	105	105	105	105	105	105	105	105	105
Clearing width B at a blade angle of 35° (cm)	270	262	295	328	360	369	410	451	492
Clearing width B at a blade angle of 45° (cm)	233	226	255	283	311	318	354	389	424
b1 35° (cm)	167	163	179	196	212	216	237	257	278
b2 35° (cm)	103	99	115	132	148	152	173	193	214
b1 45° (cm)	157	153	167	181	196	199	217	234	252
b2 45° (cm)	77	73	87	101	116	119	137	154	172
Passage width C at a blade angle of 35° (cm)	302	294	327	360	392	401	442	483	524
Passage width C at a blade angle of 45° (cm)	268	261	290	318	346	353	389	424	459
Passage width C at a blade angle of 55° (cm) with LSE	229	224	246	269	292	298	327	355	384
Weight with combination wear rail S=36, parallelogram with attachment plate VSS-A, support wheels and snow dust deflector (approx. kg)	920	970	1020	1070	1120	1170	1220	1270	1370



Photos show snow plough with special equipment



Snow plough VARIO4

Trip edge system:
Cable-pull system

Due to its variably adjustable blade form, the VARIO4 is an all-rounder, which makes it a versatile snow plough.

The blade form can be hydraulically adjusted to suit the assignment. The open form enables high quantities of snow to be thrown over high snow embankments, the closed form being ideal for high clearance speeds.



TECHNICAL DATA

	320	340	360	400	450	500	600
Spring elements (no.)	4	4	4	4	5	5	6
Plough length (cm)	320	340	360	400	450	500	600
Plough height with steel wear rail (cm)	105-135	105-135	105-135	105-135	105-135	105-135	105-135
Clearing width B at a blade angle of 35° (cm)	262	279	295	328	318	410	492
Clearing width B at a blade angle of 45° (cm)	226	240	255	283	369	354	424
b1 35° (cm)	158	166	174	191	211	232	273
b2 35° (cm)	104	112	120	137	157	178	219
b1 45° (cm)	146	153	160	174	192	210	245
b2 45° (cm)	80	87	94	108	126	144	179
Passage width C at a blade angle of 35° (cm)	297	314	330	363	404	445	527
Passage width C at a blade angle of 45° (cm)	265	279	294	322	357	393	463
Passage width C at a blade angle of 55° (cm) with LSE	219	231	242	265	294	323	380
Weight with combination wear rail S=36, parallelogram with attachment plate VSS-A, support wheels and snow dust deflector (approx. kg)	1140	1170	1200	1260	1390	1460	1660

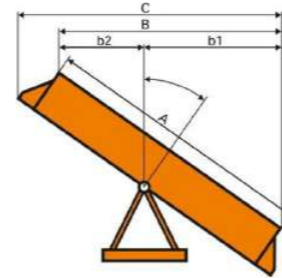

Photos show snow plough with special equipment

Snow plough SP3000

Trip edge system:
Lever-controlled

The SP3000 snow plough was specially developed for use at airports.

With a plough length of up to 800 cm, an airfield can be cleared of snow within the shortest time. In order to reduce the passage width, the outer elements of the 750C and 800C models can be folded in.



TECHNICAL DATA

	560	600	750	750c	800c
Spring elements (no.)	4	4	5	5	5
Plough length (cm)	560	600	750	750	800
Plough height with steel wear rail (cm)	130	130	130	130	130
Clearing width B at a blade angle of 35° (cm)	485	490	614	614	655
b1 35° (cm)	264	280	342	342	363
b2 35° (cm)	194	210	272	272	292
Passage width C at a blade angle of 35° (cm)	496	528	642	642	691
Weight with attachment plate, electrical pump unit and support wheels (approx. kg)	1550	1600	1750	1950	2000
Folding outer elements	no		yes		

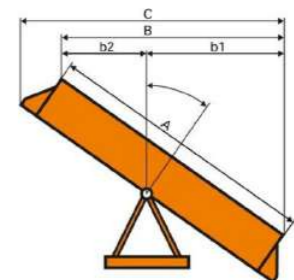

Photos show snow plough with special equipment

Side-blade snow plough SFRG22K

The SFR is a side-blade snow plough with an open blade form. This enables the snow to be cast widely.



Trip edge system:
Cable-pull system

TECHNICAL DATA

	300-2	390-3	390-3*
Spring elements (no.)	2	3	3
Plough length (cm)	300	390	390
Plough height at the outside (cm)	130	130	130
Plough height inside (cm)	55	55	55
Clearing width B at a blade angle of 45° (cm)	212	275	320 (at 55°)
Weight with attachment plate VSS-B (approx. kg)	660	770	900

* Attachment plate EN154342 F1 with hydraulic locking



Photos show snow plough with special equipment

Side-blade snow plough SG50K

The SG50K is the closed variant of the side snow plough.

Clearing widths of up to 7.5 m are possible in combination with a G50K-550-5-45°+10°.

Due to its hydraulic locking on an EN15432 F1 mounting plate, it can be mounted and dismantled within a very short time.



Trip edge system:
Cable-pull system

TECHNICAL DATA

	440
Spring elements (no.)	4
Plough length (cm)	440
Plough height (cm)	106
Clearing width B at a blade angle of 55° (cm)	360
Weight with attachment plate DIN 76060-A (approx. kg)	1150



Photos show snow plough with special equipment

Side plough SSR

In combination with a front snow plough, the side plough is a clearing width extension.

Due to the lateral mounting on the truck, the snow is thrown further outwards.

When swivelled in, it only slightly widens the contour of the carrier vehicle (passage width).



TECHNICAL DATA

	250	300
Plough length (cm)	250	300
Plough height at the outside (cm)	140	140
Plough height inside (cm)	75	75
Clearing width B at a blade angle of 45° (cm)	176	212
Weight with combination wear rail S=36 and attachment plate VSS-B (approx. kg)	500	550



Photos show snow plough with special equipment



Mounting devices

Every snow plough can be equipped with different mounting devices to suit the carrier vehicle and the mounting situation.

Mounting plate (VSS, DIN 76060, EN 15432) with parallelogram

This can optionally be equipped with a lateral swivel unit. This additional swivel cylinder enables the centring of the snow plough in a swivelled position or a reduction of the passage width.



Wheel loader mount

Ground unevenness is compensated with the parallelogram mount matching the quick coupler. This can be damped with a spring package if desired.

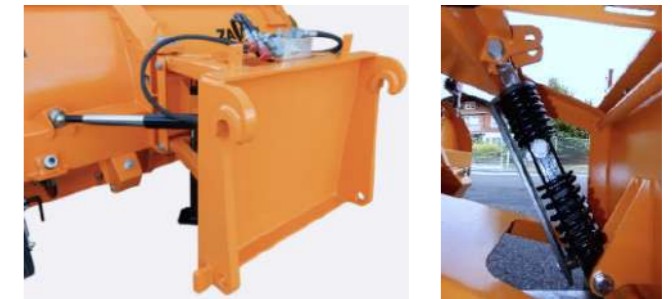

3-point mount

The versatile adjustment options enable the optimised mounting of the snow plough on the carrier vehicle. It is possible to change the mounting category by exchanging the connecting parts.



A large number of mounting devices are offered for municipal implement carriers for the optimal mounting of the snow plough.



Options

Snow dust deflector Snow guide plate

In order to minimise the swirling up of snow onto the vehicle's windscreen, it is possible to mount an adjustable snow dust deflector. Hydraulic adjustment is possible as an additional option.

The snow guide plate extends the closed blade form.



Snow guide rubber

The snow guide rubber is a flexible extension of the plough body. With an open plough body, it makes the snow "roll", thus preventing it getting over the top of the plough blade. Therefore, it performs a similar function to the snow dust deflector.



Kerbstone guard Edge guard

Kerbstone guards are available in various sizes in steel and rubber. The edge guard protects the wear rail corners against excessive wear due to kerbstone.

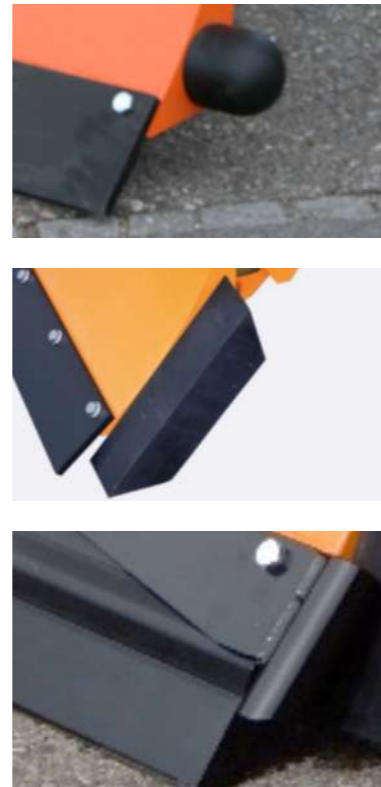

Side plate

The clearance of snow from squares and open spaces is considerably simplified with the aid of side plates. If they are swivelled forwards, mechanically actuated by hand, the snow can be transported with them.



Fine finish bar

The fine finish bar has X-part polyurethane wear rails. With the hydraulic lifting device, the contact pressure against the road surface is adjusted and set via a hydraulic accumulator.



Ice scraper

The ice scraper with tungsten carbide chisel is suitable for removing ice from icy or uneven snow-covered roads. Chisel segments with pivot point suspension ensure impact protection by means of shear pin fastening. The hydraulic depth setting enables individual use.



Orientation aids

As an alternative to the conventional fanion on the edge of the plough, reflective Lumifog bars are also available as orientation aids. These can also be equipped with LEDs on request.

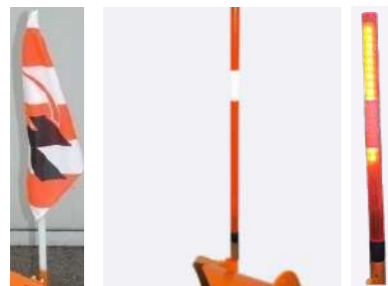

LED-headlights, LED-flashing position lamps

If the lighting system on the carrier vehicle is obscured by the snow plough, a large number of different lighting options are available.



Side flaps

The side flaps perform a flexible double function as a snow carrier and snow dust deflector. The side flaps are hydraulically adjustable to the left and right as well as individually. In a vertical position on the side they act as an ejection blocker and in the horizontal position transversely above the snow plough as a snow dust deflector.



Controllers

If a carrier vehicle does not have the necessary hydraulic functions, a large number of control variants can be supplied.

If the carrier vehicle is equipped with a hydraulic system, a control valve block can be fitted to the snow plough for the necessary functions. If there are no hydraulics, there is an option to install a completely autonomous hydraulic system. Only a power supply from the carrier vehicle is required for this.



ZAG 107

This controller is designed for versatility and is available for 12 or 24 V operations. It can be fitted to any kind of vehicle.



ZRS 102

The ZRS-102 controller is equipped with two function levels.

The blade pressure regulation for load relief or load application is infinitely adjustable via a scale value. The control function can be switched to the floating position function by means of a key function.



ZRS 202

The two-joystick operation of the ZRS 202 is ideally suited for the joint use of front and side blades.

The blade pressure regulation for load relief or load application is infinitely adjustable via a scale value. The control function can be switched to the floating position function by means of a key function.



ZRS 112

Enables the front snow plough to be controlled in proportion to the joystick movements. Various additional functions can be operated via a second level.

After-sales

We accompany you on your way with your ZAUGG product. Our customer service is available to you around the clock!

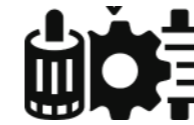

Spare parts



Maintenance and inspection

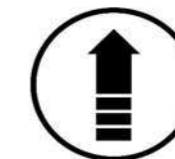

Innovative improvements



Product training



Assessment



Straightening and welding



Painting



Maintenance and assembly

Before:



After:





Contact
US

+41 34 491 81 11
info@zaugg.swiss



ZAUGG AG EGGIWIL

ZAUGG AG EGGIWIL
Holzmatt 651b
3537 Eggwil
Switzerland